

# Liquid Filtration Accessories

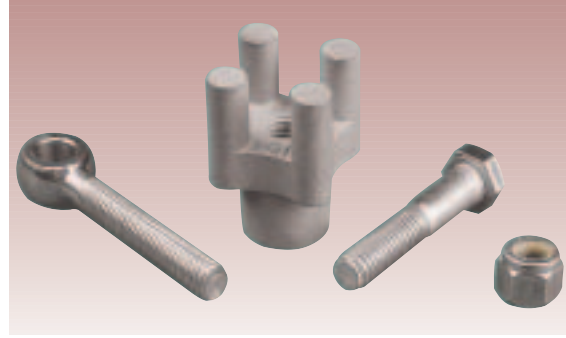

Technical Bulletin F

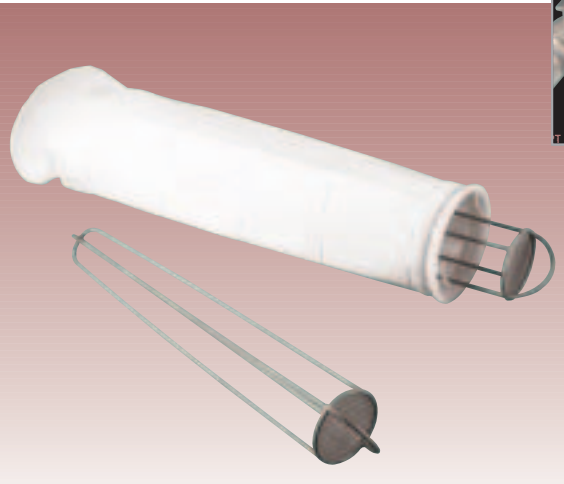
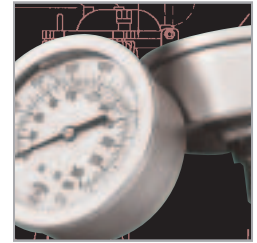
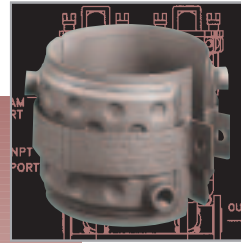
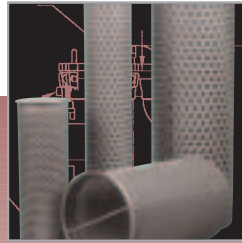
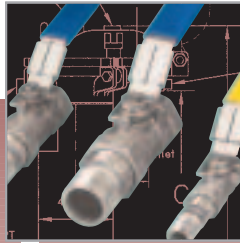

**Filtration Systems**

Division of Mechanical Mfg. Corporation

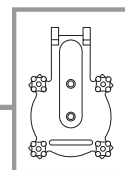

## PERFORATED SUPPORT BASKETS

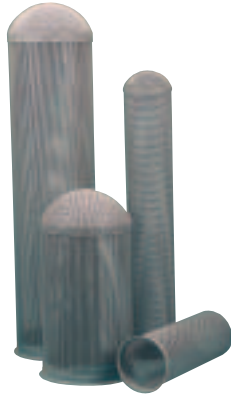

Stainless steel baskets accommodate filter bag sizes #1, 2, 4, and 5. The hemispherical shaped bottom fully supports our filter bags. Staggered pattern, perforated holes (9/64" diameter) maximize the usable surface area of any filter bag and provide greater basket strength than straight-line pattern perforations. *Filtration Systems* support baskets have a longitudinal taper to assist with filter bag removal. Available in T-316 or T-304 Stainless Steel. *Support baskets are required when using liquid filter bags.*

## MESH AND MICRON LINED BASKETS



These reusable baskets provide liquid straining and filtering at various levels of mesh and micron requirement. Fully welded construction assures that no particle bypass occurs around the welded seam of the mesh or micron lining. The lining is supported by the perforated outer wall of the basket, making it extremely durable. Ideally suited for high temperature applications and/or aggressive service, baskets are constructed of T-316 stainless steel and include a Buna gasket.

**Mesh:** 20, 30, 40, 50, 60, 70, Industrial Service  
80, 100, 150, 200

**Micron:** 40, 90, 160, 250 Industrial Service  
5, 10, 15, 25 Light-Duty, Specialty Use

## BULLET BOTTOM™ BASKETS

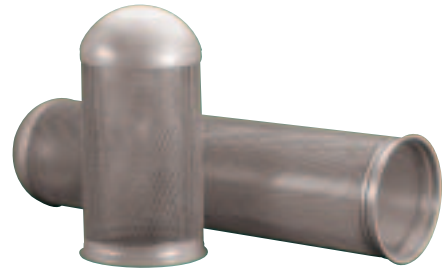

Our newly patented basket promotes "Lateral Fluid Dispersion", resulting in increased solids loading capacity, and greater differential pressure capability of the filter bag. This specialty support basket is T-316 S/S, has a perforated wall, and a solid hemispherical bottom. Available in size #1, 2, 4 and 5.

## PERFORATED STRAINER BASKETS



Heavy-duty perforated baskets convert size #1, 2, 4, and 5 filter vessels into high-capacity liquid strainers. When our filter housings are used with strainer baskets they allow heavy dirt loading at high flow rates. Perforated strainers are reusable and may be pressure cleaned, if required.

To maximize the usable surface area of the strainer basket, holes are punched in a staggered pattern. Constructed of T-304 stainless steel, strainers have a lift-out handle and a solid, flat bottom. For finer filtering applications, Mesh and Micron Lined Baskets are available. Strainer Baskets are available with the following perforations:

**1/2"** **3/8"** **1/4"** **3/16"** **9/64"** **3/32"** **1/16"** **3/64"**  
(.500) (.375) (.250) (.1875) (.1406) (.0938) (.0625) (.0469)

## CANISTER BASKETS



This accessory basket is used with a filter bag in a *Filtration Systems* housing to hold granular materials, such as activated carbon, diatomaceous earth, or resins. The addition of granular materials during the filtration process can alter the composition of liquids passing through the charged canister. For example, liquid polishing to remove odor, taste, and color can be accomplished using granular, activated carbon. To maximize the life of the granular material and prevent channeling, Canister Baskets include a liquid diffuser which promotes a spray effect. This T-316 stainless steel basket has a solid wall and a perforated bottom.

## MESH SUPPORT BASKETS



Type 316 stainless steel (8x8 mesh) basket accommodates filter bag sizes #1 and 2. These baskets have a tapered, cone-shaped bottom.

## CARTRIDGE CHAMBERS



These removable, positive sealing chambers hold four standard cartridge filters in a “Cluster of Four” arrangement. They are available in three sizes to hold standard 10”, 20”, and 30” length cartridge filters. Insertion of the chamber into any of our filter bag housings converts the vessel into a cartridge housing, *without modification of piping or change of liquid flow path*. Our chambers can accommodate many types of cartridges, with a variety of sealing arrangements, including oversized, specialty cartridges or those having double O-Ring seals or flat gaskets.

Since the contaminant is trapped within the chamber, *Filtration Systems* housings do not have to be cleaned or flushed after each use. When the cartridges are spent, the chamber (with cartridges) is removed from the vessel, minimizing spills and exposure to unfiltered liquid. Spare chambers can be preloaded so that new cartridges can replace spent ones quickly, reducing downtime. The Cartridge Chamber is fabricated of T-316 stainless steel, and includes standard sealing hardware (shown above) and a Buna gasket. Chambers are available for #1, 2, 4, and 5 housings. Longer housings and chambers are also available to hold cartridges up to 40” long.



## **FILTER BAG RESTRAINER**

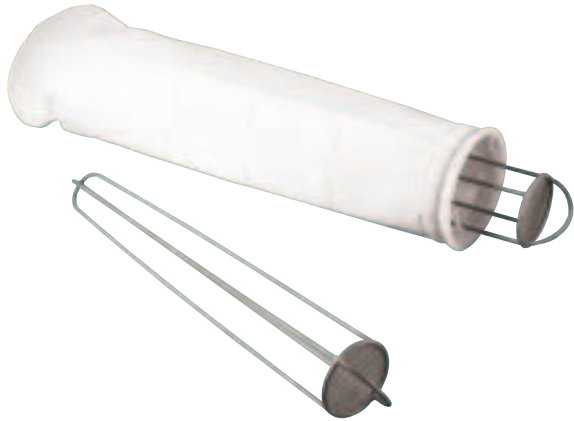

Users are assured that a filter bag is properly seated and fully extended by placing the Filter Bag Restrainer into the bag, and then installing the bag (with restrainer) into the basket. To keep the bag extended and maximize its usable surface area, the restrainer remains in the bag during the filtering process. This accessory can prevent the bag from “floating” as a result of back pressure, and may reduce media erosion due to pump vibration. A diffuser plate helps protect the bag from surges of liquid or pressure spikes. This product has a convenient handle and is fabricated of T-316 stainless steel.

## **FILTER BAG INSERT**

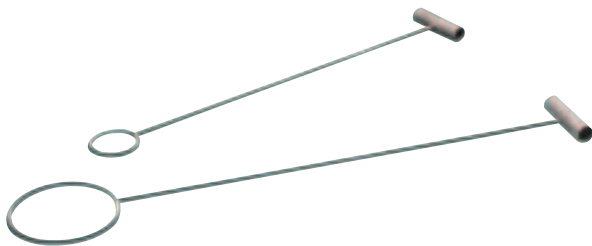

This accessory is designed to easily install filter bags, eliminating the need for technicians to reach into the bag during installation. The maximum surface area of the filter bag is used when the bag is properly seated and fully extended with this device. The Filter Bag Insert is fabricated of T-316 stainless steel and has a comfort handle.

## **LIQUID DISPLACER**

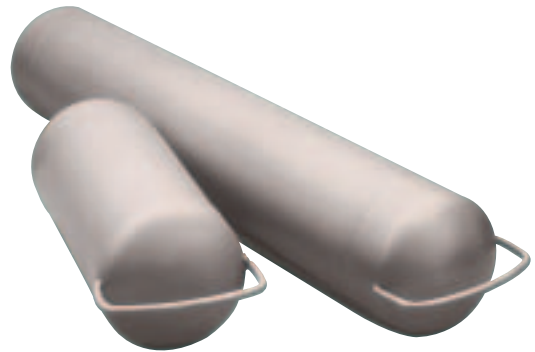

Placed into a filter bag prior to start-up, this accessory remains in the bag during the filtration process. When removed, liquid volume remaining in the bag is reduced, minimizing product loss and facilitating filter bag change-out. Liquid displacers are available in stainless and carbon steel for size #1 and 2 housings, and are equipped with a lift-out handle.

## **BASKET PREFILTER**

This reusable strainer can be placed inside a filter bag as a prefilter to capture larger particles upstream of the bag, providing dual-stage filtration within a single housing.

The prefilter basket can be removed from the housing, independent of the bag, and emptied, to provide extended filter bag life. Constructed of perforated T-316 stainless steel, the prefilter has a 90, 160, or 250 micron-rated liner.

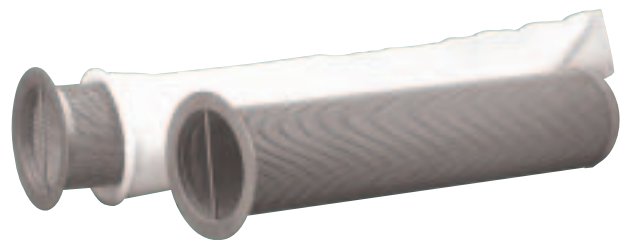

## TWO-PIECE THERMAL JACKETS



NS-130 filter housing shown with a 20" half-jacket and a 10" half-jacket.

Thermal Jackets are used to maintain a desired liquid temperature during the filtration process. Jackets can accept steam, hot oil, water, heat transfer fluids, or refrigerants. The dimpled pattern design of our jacket provides highly efficient thermal transfer.

This product is easily installed in the field by bolting two halves together, creating a tight fit on the outside of the filter vessel. Jackets are stackable and may be used in sets or singularly. Half-jackets can accommodate many vessel configurations to provide maximum coverage. Thermal Jackets have 3/4" NPT connections and bear an ASME "U" Stamp. Available in 10", 20" and 30" lengths, for 8" diameter housings, they are fabricated of stainless steel and rated for 150psi at 450°F. Thermal Jackets can retrofit most competitors' 8" diameter housings. Jackets are sold in sets.

## AMERICAN FELT & FILTER, GAF/ISP SUPPORT BASKETS AND SPECIALTY BASKETS



Perforated or Mesh Support Baskets and Specialty Baskets for AM/RB Series #1 and 2 size filter vessels are constructed of T-316 stainless steel. Specialty Baskets include Strainers, Mesh and Micron Lined Baskets, Canister Baskets, and Cartridge Chambers. These baskets require two O-Rings that fit into machined grooves on the top and the bottom of the basket flange.

## HALAR® COATED ACCESSORIES



**Halar** fluoropolymer is a thermoplastic manufactured by Solvay Solexis, Inc. It is electrostatically applied, then baked in multiple coats, to all wetted surfaces of *Filtration Systems* single filter vessels, as well as most baskets, perforated strainers, and accessories.

**Halar** fluoropolymer coating...

- 1) Offers a broad range of chemical resistance qualities which are useful when filtering liquids that are incompatible with stainless or carbon steel.
- 2) Assures a seamless filtering environment, ideal for high-purity applications.
- 3) Resists peeling and is extremely durable.

*Filtration Systems* is recognized as a qualified **Halar** applicator. Please ask us to fax Solvay Solexis, Inc. Halar Chemical Resistance Guide for your application.

**Halar** is a registered Trademark of Solvay Solexis, Inc.



## PIPE-END FILTER SYSTEM



This system is ideally suited for various types of liquid straining and filtering applications, typically found in industry, including:

- 1) Permanent installation to a Pipe-End for bulk loading or high-volume tank filling.
- 2) Connection to an industrial hose for filtering liquid deliveries to a production/distribution facility. The filter bag may be removed and easily inspected to evaluate the purity of a delivery.



The Pipe-End Filter System provides effective, low-cost filtration without the nuisance or hazard of spillage. A shut-off valve isolates the filter during bag change-out, minimizing waste and employee exposure. Handles allow easy removal of the basket and filter bag. The quick-opening, cam & groove mechanism is easier to use than clamp-style, unsupported devices.

Constructed of T-316 stainless steel, the system includes a *Filtration Systems* Ball Valve and a Perforated Support Basket for #5 size filter bags (4" dia. x 24" long). Perforated Strainers, Micron-Lined Baskets, Cartridge Chambers, and Canister Baskets for activated carbon can also be used with the Pipe-End Filter System. The standard connection is 1-1/4" NPT and may be modified to fit larger diameter pipes or hoses (up to 3"). It is suitable for flow rates up to 50gpm.

## SANITARY VALVES & FITTINGS

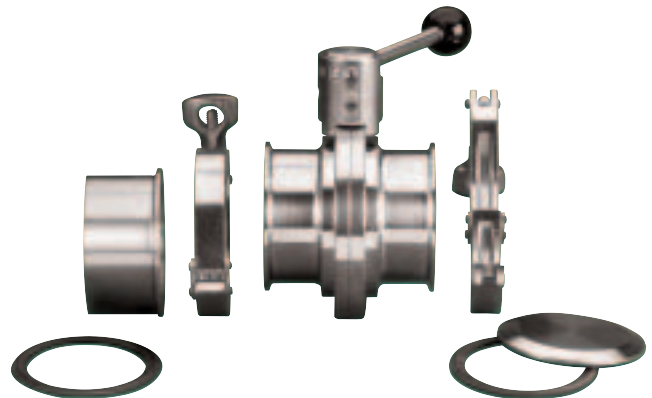

*Filtration Systems* Butterfly Valves and Fittings meet the stringent requirements of sanitary applications, including Dairy, Pharmaceutical, Biotechnology, Electronic, Cosmetic, and Food & Beverage Industries. Clamp-style, Sanitary Valves allow Clean in Place (CIP) capability or easy removal for maintenance, sanitation or sterilization.

Four-position Butterfly Valves are designed in accordance with 3-A Sanitary Standards, and are fabricated of T-316 Stainless Steel. Valve sizes include 1", 1-1/2", 2", 2-1/2", 3", or 4", with EPDM Seals (Silicone and Viton Seals also available). Sanitary Fittings (ferrules) are fabricated of T-316L Stainless Steel and match Tri-Clamp® brand connections. Fittings are available in 1/2", 3/4", 1", 1-1/2", 2", 2-1/2", 3", or 4". Sanitary Butterfly Valves and Fittings are sold separately, and are optional on all *Filtration Systems* Housings.

*Tri-Clamp* is a registered Trademark of Alfa Laval, Inc.

## AUXILIARY VALVES

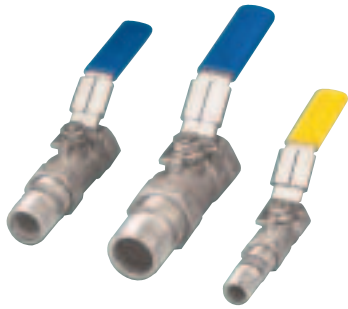

All *Filtration Systems* housings feature a vent port in the lid and a drain port at the base of the filter for installation of auxiliary valves. Vent valves may be installed at the top of the lid to remove air pockets from process fluid lines and promote faster gravity drainage, when used in conjunction with the inlet and outlet drain valves.

The outlet drain valve allows the collection of filtered liquid after the vessel is taken off-line. During operation, this valve may also be used for sampling filtered liquid. The upstream drain port and valve on our housings, allows sampling of pre-filtered liquid. Ball valves are available in stainless steel or brass, and are supplied with stainless steel nipples.

*Filtration Systems* housings are equipped with the following threaded ports:

**Vent Port:** 1/4" NPT (all housings)

**Upstream Drain Port:** 1/4" NPT (all housings)

**Downstream Drain Port:** 3/4" NPT (#1 & 2 size)  
1/2" NPT (#4 & 5 size)

## GAUGES



All *Filtration Systems* housings feature two gauge ports (1/4" NPT) to allow users to monitor both the upstream and downstream pressure. The variance between the two readings is called the *differential pressure*, and is used to determine when a filter bag is “blinding”, requiring change-out. Gauges have a 2-1/2" dial, 1/4" NPT connections, and are back-center mounted.

They are available in three ranges: 0-100psi, 0-160psi, and 0-300psi. All gauges have a stainless steel case, and may be ordered with either brass or stainless internals.

## LOW-PROFILE, HORIZONTAL OUTLET



This one-piece, self-draining outlet, exclusive to the *Filtration Systems* product line, is optional on all #1 and 2 size filter vessels. This upgrade reduces filter bag removal clearance height by 4" on single vessels and 3" on modular systems, eliminating the need for a ladder or platform when changing filter bags. As a result, ergonomic related injuries and accidental spills during change-out may be reduced.

The low-profile “LP” feature may be used on equipment with flanged, threaded, or sanitary connections and is available in stainless and carbon steel. The “LP” outlet on the filter vessel, relative to the inlet, can be positioned to accommodate custom piping arrangements (See Bulletin A, B, or Technical Illustration F).

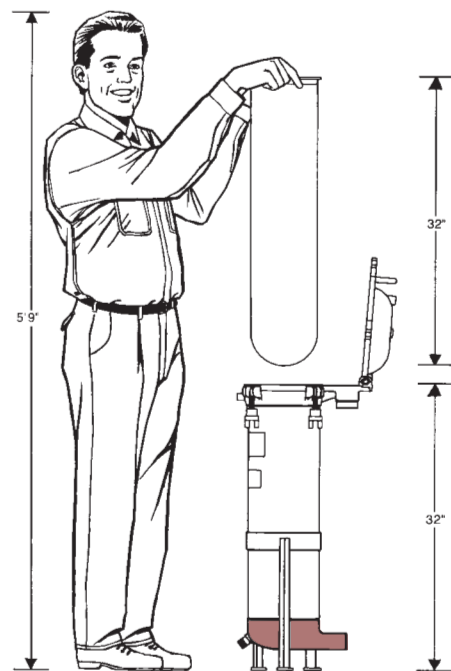

Lower working height means easier filter bag change-out for operators.

## REPLACEMENT HARDWARE



Replacement hardware is available in stainless or carbon steel for *Filtration Systems* ASME Code and Industrial Grade vessels. *Filtration Systems Over-The-Top™* vessels utilize four swing-bolt assemblies to secure the lid. A hardware assembly consists of four component parts: bar knob, eyebolt, axle bolt, and axle nut.

## ADJUSTABLE TRIPOD STANDS AND WALL BRACKETS



Available in stainless and carbon steel for size #1, 2, 4, and 5 filter vessels, these stands allow the user to raise and lower the filter vessel, as required. A Wall Bracket is available for mounting #4 & 5 size housings to a wall.

## BAR KNOB WRENCH

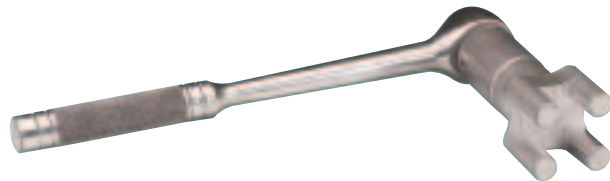

Although no special tools are required to seal our housings, a Bar Knob Wrench is an ideal accessory. This convenient device allows operators to quickly torque or loosen the lid closure nuts (bar knobs) of a filter vessel. This ratchet wrench is fabricated of plated carbon steel and may be used on all *Filtration Systems* housings.

## O-RINGS

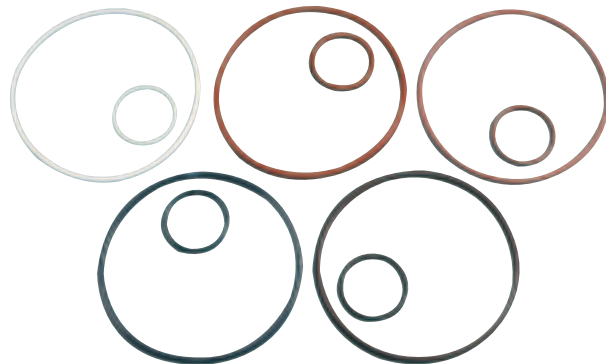

Two O-Rings are required in the lid of each *Filtration Systems* housing for proper sealing. All housings are shipped with Buna O-Rings installed. Alternate O-Ring materials include EPR/EPDM, Neoprene, Silicone, *Teflon®*, *Viton®*, *AFLAS®*, Encapsulated *Teflon/Silicone*, and Encapsulated *Teflon/Viton*. Replacement O-Rings are sold in sets of two. *Please consult the factory for information regarding chemical and thermal compatibility.*

**TEFLON** is a Registered Trademark of the DuPont Company  
**VITON** is a Registered Trademark of DuPont Dow Elastomers  
**AFLAS** is a Registered Trademark of Asahi Glass Co., Ltd.

©2005 Mechanical Manufacturing Corporation

**Warranty:** *Filtration Systems* warrants our products to be free from defects in workmanship for a period of one year from the date of purchase, when used in accordance with our specific guidelines. Our only obligation and a customer's remedy, subject to our inspection and evaluation, shall be to repair or replace the product, or refund the purchase price.

**Limitation of Liability:** *Filtration Systems* shall not be held responsible or liable for any loss resulting from the resale, direct or indirect use of this product.

## **Filtration Systems™**

Division of Mechanical Mfg. Corporation  
10304 N.W. 50th Street • Sunrise, FL 33351 USA  
Tel: 954-572-2700 • Fax: 954-572-3401  
[www.filtrationsystems.com](http://www.filtrationsystems.com)

ISO 9001: 2000 Certified

F-7/05